

# Novel DLQ Algorithm for Energy Constrained Network Discovery in WSN

ABY K THOMAS  
Sathyabama University  
Chennai  
INDIA

R DEVANATHAN  
Hindustan Institute of Technology and Science  
Chennai  
INDIA

abykt2012in@gmail.com devanathanr@hindustanuniv.ac.in

*Abstract* - Neighbor discovery is the determination of all nodes in the network that can communicate with a given node. Routing typically begins with neighbour discovery. Discovering neighbours should be both quick as well as energy efficient. Many algorithms which mostly work at a protocol level had been developed for neighbour discovery. Here a new method for neighbour node discovery that maximizes network lifetime is proposed. The basic idea accounts for clustering using Hausdorff distance and selecting wireless links having good link quality for routing packets. The nodes form clusters based on the Hausdorff distance. The clusters are formed only once but the role of cluster head is rotated among the cluster members. After cluster formation, the wireless link quality and minimum Hausdorff distance is checked for inter cluster communication. The link having better reliability is selected which minimizes the retransmissions and manages energy. Re-clustering is done when the energy of cluster head falls below particular threshold energy.

*Keywords* - Hausdorff distance, Link quality indicator, Cluster head scheduling, multi-level hierarchy, Network lifetime, Residual energy, duty cycle

## 1. Introduction

The advancements in electronics and wireless communication have brought a significant development of networks of low-cost, low-power and multifunctional sensors which received worldwide attention. These sensors are small in size and they have properties like sensing, processing and communicating with each other, typically over a radio frequency channel. A wide range of applications include agriculture, machine surveillance, area monitoring, health care etc. Basic features of sensor networks include their self-organizing capabilities, short-range communication, multihop routing, dense deployment and cooperative effort of sensor nodes. Frequently changing topology, limitations in energy, power, memory etc are some of the short comings of WSN. Energy efficient wireless communication systems are being studied and are typical of WSNs. A multi hop RF network provides a significant energy saving over a single-hop network over same distance because of the unique attenuation characteristics of radio frequency signals. Many other techniques that increase network lifetime are being developed now.

Neighbour discovery is the determination of all nodes that can directly communicate with a given node. Routing typically begins with neighbour discovery. Reducing energy consumption in the network discovery phase is therefore particularly important. Recently, a number of studies on neighbour discovery algorithms have appeared [5], [6], [9] but most of them worked at the protocol level.

Nodes in a sensor network often need to organize themselves into clusters. Clustering allows hierarchical structures to be built on the nodes and enables more efficient use of scarce resources such as bandwidth, power, frequency spectrum etc. Clustering also allows the health of network to be monitored and misbehaving nodes to be identified. Many clustering algorithms have been developed recently. LEACH [7] is one of the most popular clustering algorithms for WSNs. It forms clusters based on the received signal strength and uses the Cluster Head (CH) nodes as routers to the base station. All the data processing such as data fusion and aggregation are local to the cluster. In the hierarchical control clustering proposed in [10], the main aim is to form a multi-tier hierarchical clustering where any node in the WSN can initiate the

cluster formation process. Another distributed clustering algorithm called HEED was developed [3] in which CH nodes are picked from the deployed sensors. Unlike LEACH, it does not select cluster head nodes randomly. Instead nodes that have a high residual energy can become cluster head nodes. Bandyopadhyay et al [4] proposed a distributed, randomized clustering algorithm to organize the sensors in a WSN into clusters. Authors observe that the energy savings increase with the number of levels in the hierarchy of cluster heads. Banerjee and Khuller [11] proposed a clustering algorithm to create a set of desired clusters.

In this paper we propose a neighbour discovery method that minimizes energy consumption and maximizes network lifetime. In the beginning all nodes in the network will be having equal energy. So one of the nodes will be assigned as the initiator and this initiator then selects nodes to form clusters according to some cluster conditions. After cluster formation one of the members elects to be cluster head. Before any transmissions occur, anyone can become the CH. But after some transmissions, the node having the highest residual energy becomes the CH. For inter cluster communication, the wireless link quality and minimum Hausdorff distance is checked for.

The rest of the paper is organized as follows. Section II describes the related works. Section III describes the problem statement; Section IV describes the energy model. Section V explains the Distance and link quality (DLQ) based algorithm. Section VI shows the simulation results and finally section VII gives the conclusions.

## 2. Related Works

Recently a number of studies on neighbour discovery algorithms have appeared [5],[6],[9]. Algorithms for neighbourhood discovery are either deterministic [17], rely on probabilistic approaches [15], [16] or use group testing strategies [13], [14]. Probabilistic approaches for neighbourhood discovery assume slotted behaviour for communication and belong to the class of random-access protocols. Depending on chosen policies, participating nodes send and receive messages with probabilities that are either fixed or adaptive at every slot. For example, Mc Glynn et al. [15] address the energy-efficient neighbourhood discovery problem at deployment time for a static WSN. They consider the fraction of links that are discovered per time unit in a clique of  $N$  nodes.

Vasudevan et al. [16] model neighbourhood discovery as a coupon collector's problem. He formulated two algorithms, one that is Aloha-like and the other that relies on collision detection mechanisms. Both the algorithms are adaptive in nature, and typically involve nodes decreasing their transmission probabilities progressively over expanding intervals of time. In contrast to probabilistic transmission, discovery algorithms that use group testing are designed for identifying a small subset of nodes as neighbors from a much larger set. The algorithms in [13], [12] work by a simple principle of elimination, wherein a central node initiates a series of so called signatures from its neighbors. A signature from a neighbor is typically a collection of binary responses, which are logically ORed to infer proximity. Nodes that are unresponsive are considered as not being neighbors. These algorithms score over the random access discovery schemes mainly on latency. In the paper proposed by Xiarong Zhu et al. [8], clustering using Hausdorff distance was developed but there was no consideration on the quality of links. Link quality is an important parameter that can minimize retransmissions and reduce energy consumption since it was found that transmitting a single bit of data takes 800 times more energy than executing an instruction.

## 3. Background

The proposed approach will create a system in which size of a cluster, nodes in a cluster and level of hierarchy of a cluster will vary according to the state and traffic pattern of the system. Nodes are assumed to have multiple energy levels for energy efficient clustering

### 3.1 Multilevel Hierarchy

The multilevel hierarchy used is shown in Fig.1 and can be described as follows

- Set of nodes of equal energy cover the entire network
- Assign an initiator first
- Initiator selects nodes to its cluster according to Hausdorff distance and maximum two hops from initiator.
- CH selected after cluster formation
  - \* *One node allowed in only one cluster*
  - \* *Node to cluster head: maximum two hop*

\* CH to CH: multi level hierarchy

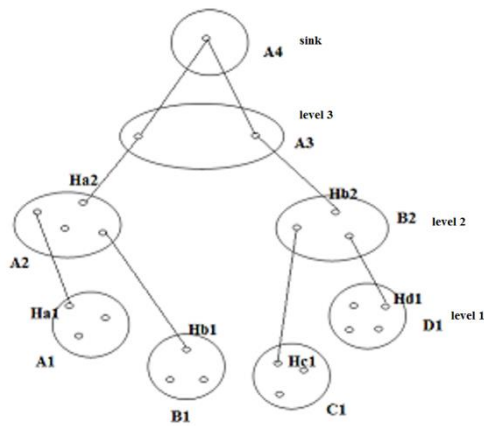

Fig. 1. Multi level hierarchy

3.2 Energy Model

We use a first order low energy radio model proposed in [1]. It includes the following:

Let  $\epsilon_{TX}(k, d)$  be the energy [7], [18] consumed to transmit  $k$  bits message over a distance  $d$ :

$$\epsilon_{TX}(k, d) = \epsilon_{elec} * k + \epsilon_{amp} * k * d^2 \quad (1)$$

Where  $\epsilon_{elec}$  is the energy dissipated by radio to run the transmitter or receiver electronic circuitry and  $\epsilon_{amp}$  is the energy dissipated by the transmit amplifier to achieve an acceptable Signal to Noise ratio ( $E_b/N_o$ ).

Let  $\epsilon_{Rx}$  be the energy consumed to receive a  $k$  bits message:

$$\epsilon_{Rx}(k, d) = \epsilon_{Rx-elec}(k) = \epsilon_{elec} * k \quad (2)$$

Here, for the simulation purpose the value considered are

$$\epsilon_{elec} = 50 \text{ nJ/bit} \text{ and } \epsilon_{amp} = 100 \text{ pJ/bit/m}^2$$

4. DLQ clustering Algorithm

For the past few decades wireless sensor networks have significantly drawn extensive attention of the research community. The sensor nodes are characterized by self organising ability and energy constraint. One of the most important challenges faced in the development of WSN is the optimal energy management. The proposed system focuses on developing a Distance and Link Quality based protocol (DLQ) based on two criteria. One is clustering based on Hausdorff distance and other is link quality metric

as shown in fig 2. Other enhancements are also added to reduce energy consumption.

This section explains about Hausdorff distance [2], Link quality indicator metric [1], and cluster conditions and discusses the properties of clusters generated.

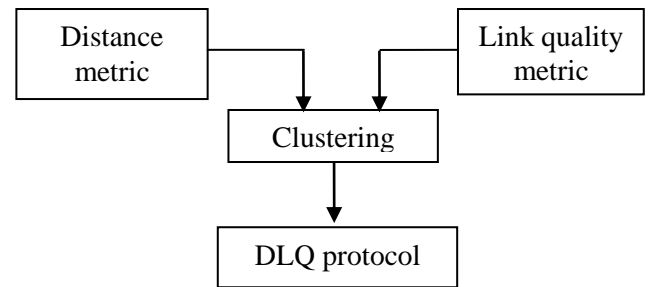

Fig. 2. Block diagram of proposed method

4.1 Hausdorff distance

Named after Felix Hausdorff, Hausdorff distance is the maximum distance of a set to the nearest point in the other set. More formally, Hausdorff distance from set  $A$  to set  $B$  is a maximin function, defined as

$$h(A, B) = \max_{a \in A} \{ \min_{b \in B} \{ d(a, b) \} \}$$

where  $a$  and  $b$  are points of sets  $A$  and  $B$  respectively, and  $d(a, b)$  is any metric between these points; for simplicity, we take  $d(a, b)$  as the Euclidian distance between  $a$  and  $b$ .

It should be noted that Hausdorff distance is oriented (we could say asymmetric as well), which means that most of the times  $h(A, B)$  is not equal to  $h(B, A)$ . This general condition also holds for the example of Fig. 3. This asymmetry is a property of maximin functions, while minimin functions are symmetric.

A more general definition of Hausdorff distance can be given as follows.

The Euclidean distance between node  $m$  and node  $n$  be denoted as

$$d(V_m, V_n) = ((X_m - X_n)^2 + (Y_m - Y_n)^2)^{1/2} \quad (2)$$

Then, the smallest distance from node  $m$  of one cluster to another cluster  $C_j$  is

$$d(V_m, C_j) = \min \{ d(V_m, V_n) : V_n \in C_j \} \quad (3)$$

The directed Hausdorff distance [2], [8] from cluster  $C_i$  to  $C_j$ , denoted as  $h(C_i, C_j)$ , is the largest value for the  $v_m$  concerned

$$h(C_i, C_j) = \max\{d(V_m, C_j) : V_m \in C_i\} \quad (4)$$

The Hausdorff distance between clusters  $C_i$  and  $C_j$  is simply the larger of the two directed distance or

$$H(C_i, C_j) = \max(h(C_i, C_j), h(C_j, C_i)) \quad (5)$$

In short Hausdorff distance is maximum of minimums. On the other hand Euclidean distance is minimum of minimums. There are two drawbacks of shortest distance. Firstly it does not consider the whole shape. Secondly it does not consider the position of objects. Hausdorff distance is a distance that overcomes these two drawbacks. If we are taking minimum of minimums then some points of set A will not be having points in set B to communicate. But if we are taking maximum of minimum then all points of set A will have some points in set B to communicate.

Fig.3 shows an example of calculating the Hausdorff distance. Minimum distances from set A to set B is shown. The maximum distance from these minimum distances is the Hausdorff distance from set A to set B. Similarly we have to calculate distance from set B to set A. Maximum out of these two is the directed Hausdorff distance.

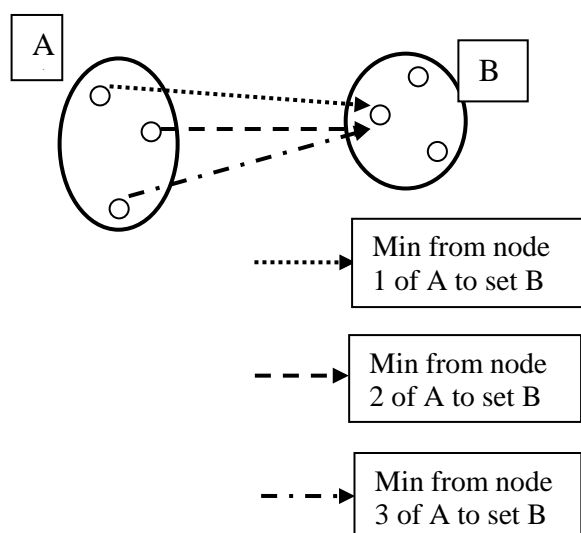

Fig. 3. Example of calculating Hausdorff distance

## 4.2 Link quality indicator

The upper layers, specifically the routing protocol, need to know about the available neighbors and also about the link quality of these neighbors. This quality information can be used to make sensible routing decisions by avoiding bad links with a high chance of packet loss. It is important to realize the following:

- The quality of a link is not binary, that is there are more link qualities than just “good” and “bad”. One way to characterize the link quality is the probability of losing a packet over this link.
- The quality of a link is time variable, for example, because of mobility or when some obstacle has moved between the two nodes.
- The quality has to be *estimated*, either actively by sending probe packets and evaluating the responses or passively by overhearing and judging the neighbour’s transmissions. Both approaches incur energy costs, which in some cases are already expended by the underlying MAC protocol as part of the neighbourhood discovery.

The neighbouring nodes and their associated link qualities are often stored in a neighbourhood table, which can be accessed by upper layers. In the case of very dense sensor networks of cheap and memory-constrained nodes, it might happen that there is not enough memory available to store all the possible neighbors. In such a case, it is desirable to select the neighbors with the best link qualities.

Link quality [1] is an important parameter that can minimize retransmissions and reduce energy consumption since it was found that transmitting a single bit of data takes 800 times more energy than executing an instruction. Fig. 4 shows an example of WSN with LQI values. LQI measurement is defined as a characterization of the strength and / or quality reception of a packet. Thus LQI measurement is performed for each received packet and the result is scaled as an integer ranging from 0 to 255. The minimum and maximum LQI values 0 and 255 respectively, are associated with the lowest and the highest quality reception detectable by the receiver. Also the LQI values in between are distributed between these two limits. LQI ranges vary from manufacturer to manufacturer.

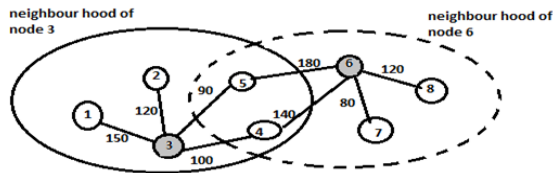

Fig. 4. Example of a WSN with LQI values

Thus LQI values are obtained from an initial function defined as :

$$LQI(S_i, S_j) = \frac{\beta + \Psi * \log(1 + (Y_j^i - Y_{\min}^i))}{\log(1 + Y_{\max}^i)} \quad (6)$$

where  $\beta = 50$ ,  $\Psi = 255$ ,  $Y_j^i = 1/d(i,j)$ ,  $Y_{\min}^i = \min(Y_j^i)$ ,  $Y_{\max}^i = \max(Y_j^i)$

$Y^i$  is a metric, which can be the remaining energy of the node or reciprocal of the distance node of the link between and sensor node  $j$ . More over  $\beta = 50$  ensures that the LQI value is not zero when the sensor  $S_j$  is located in the transmission range of node  $S_i$ .

In case there occurs a tie between clusters having same Hausdorff distance, link with an acceptable threshold will be selected.

### 4.3 Cluster formation

First all nodes will be having equal energy. So we will be assigning one node as initiator. Initiator will be adding nodes to its cluster. For that it has to check the following conditions:

1. Let first node to be added is  $x$ . Find its distance to CH. If it is below  $R_1$ , then it is added to the cluster.  $R_1$  is the lowest power for listening. (This distance is also Hausdorff distance. But since there is only one node in a set it is equivalent to Euclidean distance.
2. Take second node. Let it be  $y$ . Take distances  $x-y$  and  $CH-y$ . Take minimum of two and check whether it is two hops to CH and less than  $R_1$ . If it is so then it is added to CH, else rejected.

Similarly calculate for all nodes and form the cluster. All the clusters should be formed simultaneously. So inside a cluster, nodes should reach CH within two hops.

### 4.4 DLQ algorithm

Our goal is to design an algorithm according to clustering conditions mentioned above and the link quality indicator. First the nodes are formed randomly. Then the base station appoints an initiator for starting the clustering operation. The initiator broadcasts a clustering message and waits for join requests from neighbouring nodes. It then admits nodes according to the clustering conditions. If a node is rejected by all its neighbouring clusters, it organizes a new cluster with itself being the initiator.

The termination of the clustering algorithm depends on two cases.

1. If it is an initiator it will terminate the algorithm after all its neighbouring nodes within the range has joined the cluster
2. If it is a non-initiator it terminates the algorithm after joining the cluster

Next the initiator of each cluster starts preparation for cluster head election. The node with maximum residual energy is selected as the cluster head. The cluster head role is then optimally scheduled between the nodes of a cluster. Else as soon as the energy of cluster head is over the node dies and minimizes the network lifetime.

For inter-cluster communication the distance metric used is the Hausdorff distance. The cluster heads are arranged in a multi level hierarchy. This will reduce the energy needed to send data from cluster head to sink. We are assuming that all nodes are clustered and all clusters are connected in multi level hierarchy. The algorithm allows each node to join only one cluster.

After  $n$  transmissions the energy of cluster heads are checked. If any of its energy falls below a threshold, then cluster heads having high residual energy at that time is selected as cluster head and re-clustering is done.

### 5. Analysis and Simulation

We have developed a simulator in NS2 to evaluate the performance of proposed protocol. In this experiment a 60-node network was used. Nodes were randomly distributed between  $(x = 0, y = 0)$  and  $(x = 1000, y = 1000)$ . The bandwidth of the channel was set to 1 Mb/s and each datamess age was 500 bytes long.

### 5.1 Analysis

Below shows the snapshots of simulation output in NS-2. The commands are typed in cygwin which is a unix-like environment and command line interface running on windows where we can run NS-2. Fig. 5 shows the initial stage of nodes whereas Fig. 6 shows the cluster heads selected in red. When the re-clustering occurs cluster heads are re-elected and the re-elected CH are shown in Fig. 7.

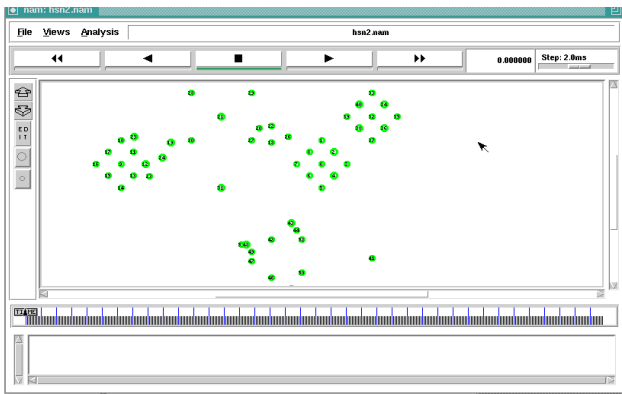

Fig. 5. Initial stage

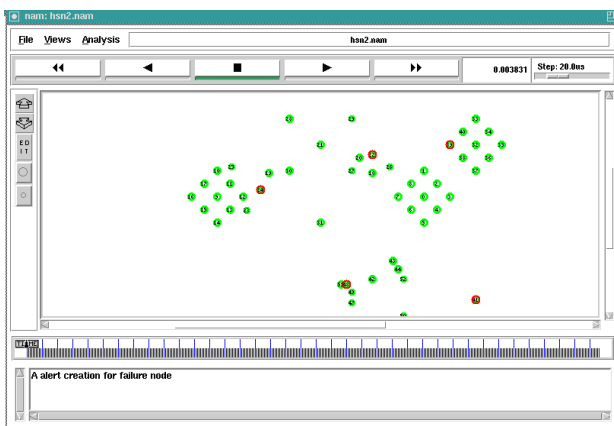

Fig. 6. Cluster heads shown in red

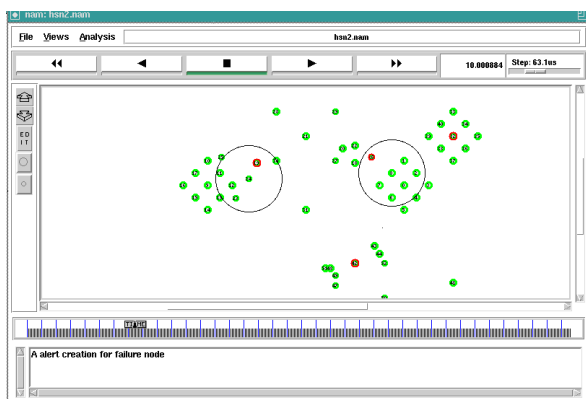

Fig. 7. Re-elected CH shown in red

### 5.2 Simulation Parameters

In this work we have used the simulation parameters given in Table 1.

Table 1 : Simulation parameters

No of nodes	60
Initial energy	1000mJ
Packet size	240bytes
Constant bit rate	8bits per sec
Network area	1000*1000m <sup>2</sup>
Re-clustering energy	991.112567mJ
Transmit power	35.2831.32*10 <sup>-3</sup> W
Receive power	31.32*10 <sup>-3</sup> W
Cluster radius	100m
Radio model	Two ray ground model
Antenna model	Omni antenna

### 6. Results

The results are plotted in graphs. The graphs showing energy consumption, packet delivery ratio, latency, and end to end delay are plotted.

Fig. 8 plots packet delivery ratio against number of transmissions. From the graph we can see that the proposed DLQ algorithm gives higher packet delivery ratio than LEACH.

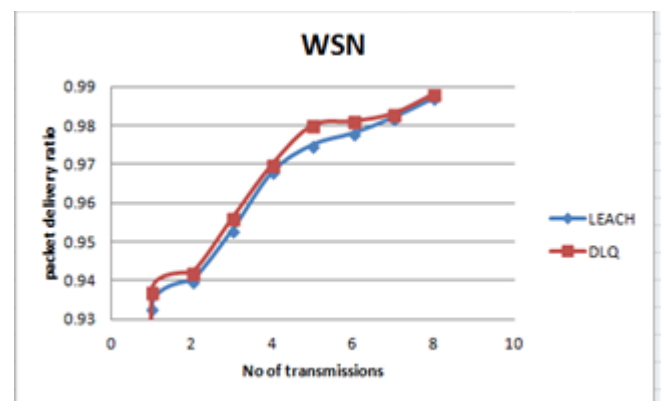

Fig. 8. Packet Delivery ratio vs. No. of transmissions

Fig. 9 plots energy consumption against number of transmissions. From the graph we can see that energy consumption is reduced compared to Leach protocol. As a result, the network so formed shows an improvement in its overall lifetime and network discovery.

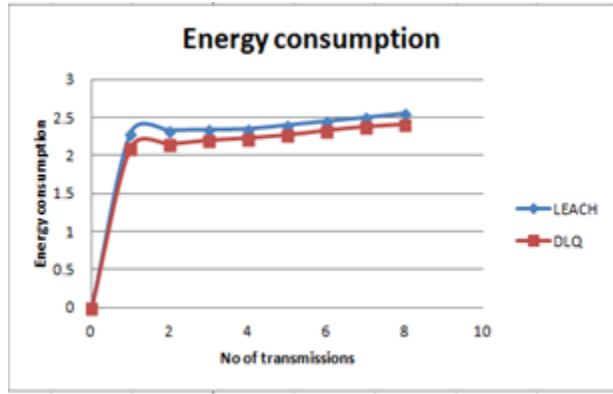

Fig. 9. Energy Consumption vs. No. of transmissions

Figs. 10 and 11 shows latency and end to end delay against number of nodes and number of CBR connections respectively. It is clear from the graphs that latency and end to end delay is less.

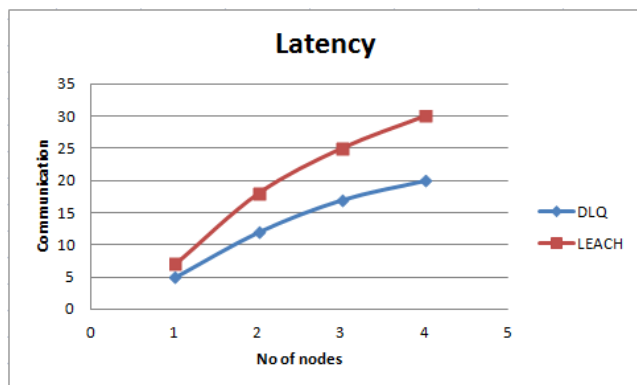

Fig. 10. Latency of network

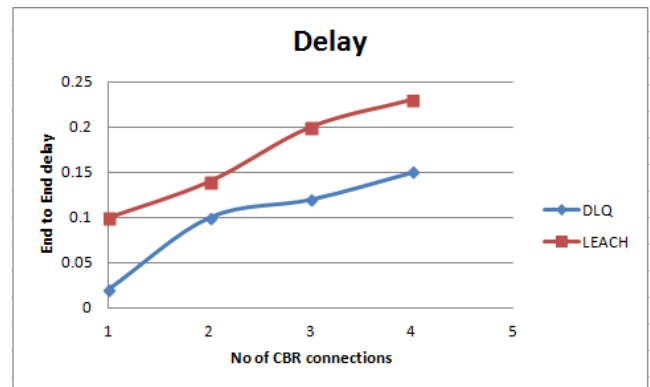

Fig. 11. End to end delay Vs No of CBR connections

## 7. Conclusions

In this paper, we have analyzed and compared the performance of the DLQ protocol in terms of their network lifetime, energy consumption, packet delivery ratio and latency with LEACH. Through the simulation we demonstrate that the proposed DLQ algorithm shows good energy distribution and thus prolongs the network lifetime in comparison to LEACH.

## References

- [1] C. Diallo, M. Marot, and M. Becker, "Single-Node Cluster reduction in WSN and Energy-Efficiency during Cluster Formation. AdHoc Networking Workshop (Med-Hoc-Net), 2010, Juan LesPins, France.
- [2] Daniel .P.Huttenlocher , Gregory .A. Klanderma and William .J.Rucklidge, "Comparing Images Using the Hausdorff distance," *IEEE Trans. Pattern analysis and Machine Intelligence*, Vol15 , no.9 , pp.850-863, sept 1993.
- [3] O Younis and S Fahmy , "HEED:A Hybrid Energy Efficient Distributed Clustering Approach for ad-hoc Sensor networks," *IEEE Trans Mobile Computing*, vol.3, no.4, pp. 366-3796 Oct -Dec 2004.
- [4] S Bandhyopadhyay and E Coyle, "An Energy - Efficient Hierarchical Clustering Algorithm for WSN" *Proc. IEEE INFOCOM*, pp 1713- 1723, April.2003
- [5] S. Vasudevan, J. Kurose, D. Towsley, "On neighbor discovery in wireless networks with directional antennas", *INFOCOM 2005*, Vol. 4, pp. 2502-2512, March 2005.

- [6] T. Narten, "Neighbor discovery and stateless auto-configuration in IPv6", *IEEE Internet Computing*, Vol. 3, Issue 4, pp. 54–62, July-Aug. 1999. FLEX Chip Signal Processor (MC68175/D), Motorola, 1996.
- [7] W. Heinzelman, A. Chandrakasan, and H. Balakrishnan, "An Application Specific Protocol Architecture for WSN," *IEEE Trans Wireless Comm*, vol 1, no 4, pp.660-670, october 2002.
- [8] Xiaorong Zhu, Lianfeng Shen, and Tak-Shing Peter Yum, *Senior Member, IEEE*, "Hausdorff Clustering and Minimum Energy Routing for Wireless Sensor Networks", *IEEE Transactions on Vehicular Technology*, vol. 58, no. 2 February 2009.
- [9] Venkatraman Iyer, Andrei Pruteanu, Stefan Dulman, "Neighborhood Discovery in Wireless Networks Using Adaptive Beacons" *IEEE International Conference on Self-Adaptive and Self-Organizing Systems*, SASO'11 Proceedings, pp. 31-40.
- [10] Z. Zhang, "Performance of neighbor discovery algorithms in mobile ad hoc self-configuring networks with directional antennas," *IEEE MILCOM*, Atlantic City, NJ, October 2005
- [11] S. Banerjee and S. Khuller, A clustering scheme for hierarchical control in multi-hop wireless networks, in *Proceedings of 20th Joint Conference of the IEEE Computer and Communications Societies (INFOCOM'01)*, Anchorage, AK, April 2001.
- [12] Holger Karl and Andreas Willing Protocols and architecture for wireless sensor networks, John Wiley and Sons Ltd.
- [13] J. Luo and D. Guo. Neighbor discovery in wireless ad hoc networks based on group testing. In *Communication, Control, and Computing, 2008 46th Annual Allerton Conference on*, pp.791-797. IEEE, 2008.
- [14] J. Luo and D. Guo. Compressed neighbor discovery for wireless ad hoc networks: the Rayleigh fading case. In *Communication, Control, and Computing, 2009. Allerton 2009. 47th Annual Allerton Conference on*, pp.308-313. IEEE, 2009.
- [15] M. McGlynn and S. Borbash. Birthday protocols for low energy deployment and flexible neighbor discovery in ad hoc wireless networks. In *Proceedings of the 2nd ACM international symposium on Mobile adhoc networking & computing*, pp.137–145. ACM, 2001.
- [16] S. Vasudevan, D. Towsley, D. Goeckel, and R. Khalili. Neighbor discovery in wireless networks and the coupon collector's problem. In *Proceedings of the 15th annual international conference on Mobile computing and networking*, pp. 181–192. ACM, 2009.
- [17] A. Keshavarzian, E. Uysal-Biyikoglu, F. Herrmann, and A. Manjeshwar. Energy-efficient link assessment in wireless sensor networks. In *INFOCOM2004. Twenty-third Annual Joint Conference of the IEEE Computer and Communications Societies*, vol.3, pp.1751–1761, IEEE, 2004.